

REV.	DATE	ECO	DESCRIPTION	BY	CK	APP
-	01/16/12	N/A	INITIAL RELEASE	GDR	N/A	N/A

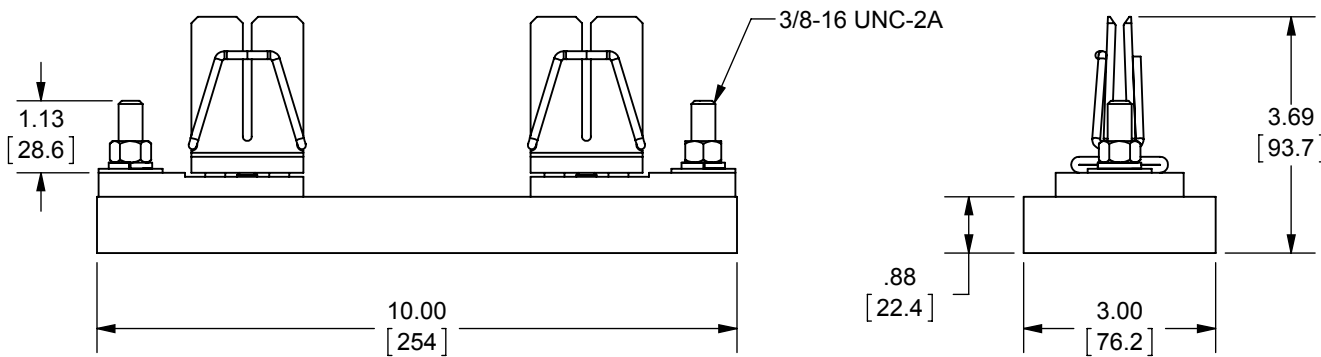

DIMENSIONS IN [ ] ARE MILLIMETERS

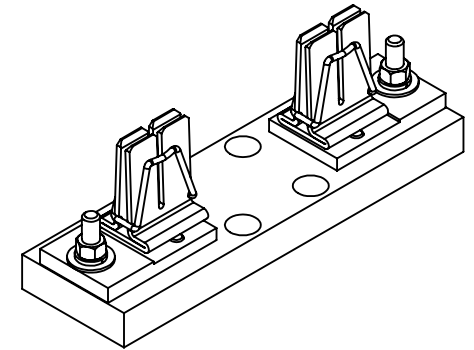
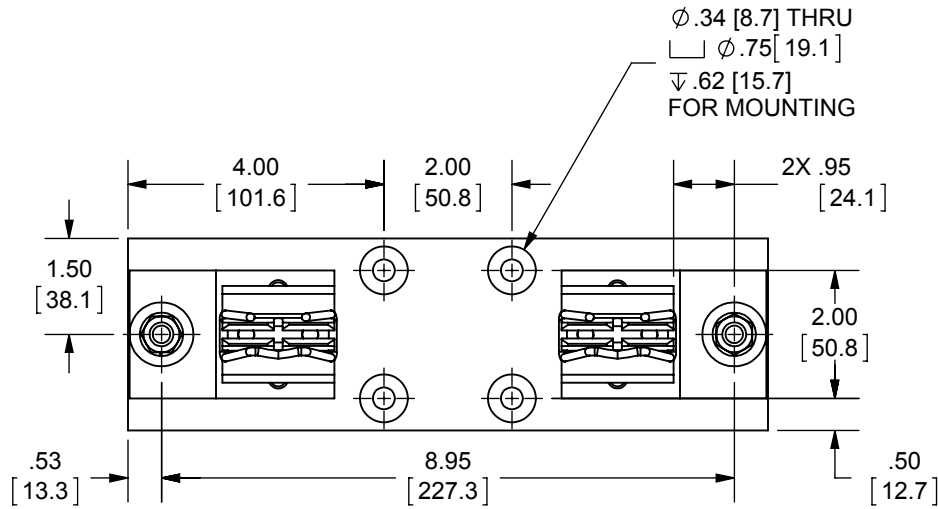

MERSEN USA NEWBURYPORT-MA, LLC  
374 MERRIMAC STREET  
NEWBURYPORT, MA 01950

64011HPJ  
PHOTOVOLTAIC FUSEHOLDER

CLASS J 1-POLE  
1000VDC 400A

OUTLINE DIMENSIONS  
NOT TO BE USED FOR PRODUCTION

701840

PRODUCT MANAGER

SIGN:

DATE:

DESIGN ENGINEER

SIGN:

DATE: